

## M5i.33xx-x16 high performance 12 bit digitizer with 10 GS/s

- Up to 10 GS/s on one or 5 GS/s on two channels
- Versions with 10 GS/s, 6.4 GS/s and 3.2 GS/s
- Up to 4.7 GHz signal bandwidth
- Ultra Fast PCI Express x16 Gen3 interface
- Streaming Speed up to 12.8 GByte/s (6.4 GS/s)
- 4 input ranges:  $\pm 200$  mV up to  $\pm 2.5$  V
- 2 GSamples (4 GByte) on-board memory
- 8 GSamples (16 GByte) optional on-board memory
- Features: Single-Shot, Streaming, Multiple Recording, Timestamps, optional Average (Standard and Threshold defined)
- Direct data transfer to CUDA GPU using SCAPP option
- Synchronization of up to 8 cards using star-hub

Speed	SNR	ENOB
10.0 GS/s	52.3 dB	8.3 ENOB
6.4 GS/s	54.0 dB	8.7 ENOB
3.2 GS/s	54.5 dB	8.8 ENOB

FPGA Option:  
Block Average up to 1M with selective averaging for TOFMS

**SCAPP**  
Spectrum's CUDA Access – Parallel Processing



**M5i series**

- PCIe x16 Gen 3 Interface
- Sustained streaming mode up to 12.8 GByte/s\*\*
- Included advanced cooling with dual cooling fans for proper airflow

Operating Systems	Programming Languages	Supported Software
<ul style="list-style-type: none"> <li>• Windows 7 (SP1), 8, 10, 11 Server 2008 R2 and newer</li> <li>• Linux Kernel 3.x, 4.x, 5.x, 6.x</li> <li>• Windows/Linux 32 and 64 bit</li> </ul>	<ul style="list-style-type: none"> <li>• C, C++, C#, Python</li> <li>• Julia, Java, VB.NET, Delphi</li> <li>• IVI</li> </ul>	<ul style="list-style-type: none"> <li>• SBench 6</li> <li>• MATLAB</li> <li>• LabVIEW</li> </ul>

Model	Resolution	1 channel	2 channels	Bandwidth
M5i.3367-x16	12 Bit	10 GS/s	5.0 GS/s	4.7 GHz
M5i.3360-x16	12 Bit	10 GS/s	-	4.7 GHz
M5i.3357-x16	12 Bit	10 GS/s	5.0 GS/s	3 GHz
M5i.3350-x16	12 Bit	10 GS/s	-	3 GHz
M5i.3337-x16	12 Bit	6.4 GS/s	3.2 GS/s	2 GHz
M5i.3330-x16	12 Bit	6.4 GS/s	-	2 GHz
M5i.3321-x16	12 Bit	3.2 GS/s	3.2 GS/s	1 GHz

### General Information

The high-performance M5i.33xx series gives outstanding performance with the combination of high resolution, high samplingrate, high bandwidth and the world fastest streaming speed for Digitizers. On selected systems the card can stream continuously one channel with 6.4 GS/s and 12 bit resolution to CPU or GPU. The M5i series is based on the common API from Spectrum and uses the same software interface like all Spectrum products released since 2005.

\*\*Throughput measured with a PCIe root complex supporting a TLP size of 512 bytes.

## Software Support

### Windows drivers

The cards are delivered with drivers for Windows 7, Windows 8, Windows 10 and Windows 11 (each 32 bit and 64 bit). Programming examples for Visual C++, Delphi, Visual Basic, VB.NET, C#, Python, Java, Julia and IVI are included.

### Linux Drivers



All cards are delivered with full Linux support. Pre compiled kernel modules are included for the most common distributions like Fedora, Suse, Ubuntu LTS or Debian. The Linux support includes SMP systems, 32 bit and 64 bit systems, versatile programming examples for GNU C++, Python and Julia, as well as the possibility to get the kernel driver sources for your own compilation.

### SBench 6

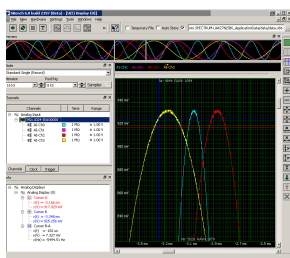

A base license of SBench 6, the easy-to-use graphical operating software for Spectrum cards, is included in the delivery. The base license makes it possible to test the card, display acquired data and make some basic measurements. It's a valuable tool for checking the card's performance and assisting with the unit's initial setup.

The cards also come with a demo license for the SBench 6 professional version. This license gives the user the opportunity to test the additional features of the professional version with their hardware. The professional version contains several advanced measurement functions, such as FFTs and X/Y display, import and export utilities as well as support for all acquisition modes including data streaming. Data streaming allows the cards to continuously acquire data and transfer it directly to the PC RAM or hard disk. SBench 6 has been optimized to handle data files of several GBytes. SBench 6 runs under Windows as well as Linux (KDE, GNOME and Unity) operating systems. A test version of SBench 6 can be downloaded directly over the internet and can run the professional version in a simulation mode without any hardware installed. Existing customers can also request a demo license for the professional version from Spectrum. More details on SBench 6 can be found in the SBench 6 data sheet.

### Third-party products

Spectrum supports the most popular third-party software products such as LabVIEW or MATLAB. All drivers come with detailed documentation and working examples are included in the delivery.

### SCAPP – CUDA GPU based data processing

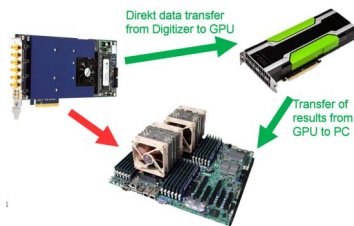

For applications requiring high performance signal and data processing Spectrum offers SCAPP (Spectrum's CUDA Access for Parallel Processing). The SCAPP SDK allows a direct link between Spectrum digitizers, AWGs or Digital Data Acquisition

Cards and CUDA based GPU cards. Once in the GPU users can harness the processing power of the GPU's multiple (up to 10000) processing cores and large (up to 48 GB) memories. SCAPP uses an RDMA (Linux only) process to send data at the full PCIe transfer speed to and from the GPU card. The SDK includes a set of examples for interaction between the Spectrum card and the GPU card and another set of CUDA parallel processing examples with easy

building blocks for basic functions like filtering, averaging, data demultiplexing, data conversion or FFT. All the software is based on C/C++ and can easily be implemented, expanded and modified with normal programming skills.

### Hardware features and options

#### PCI Express x16

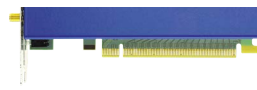

The M5i series cards use a PCI Express x16 Gen 3 connection. They can be used in PCI Express x16 slots with hosts supporting Gen1, Gen2, Gen3 or Gen4.

Gen3 or Gen4 is needed to get full performance. The maximum sustained data transfer rate is more than 12.8 GByte/s per slot on systems with a PCIe payload size of 512. Physically supported slots that are electrically connected with less lanes can also be used with the M5i series cards, but with reduced data transfer rates.

### Connections

The cards are equipped with SMA connectors for the analog signals as well as for clock input and output, trigger input and four multi-function I/O connectors (X0, X1, X2, X3). These multi-function connectors can be individually programmed to perform different functions:

- Trigger output
- Status output (armed, triggered, ready, ...)
- Synchronous digital inputs, being stored inside the analog data samples
- Asynchronous I/O lines
- Logic trigger inputs

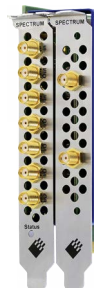

### Input Amplifier

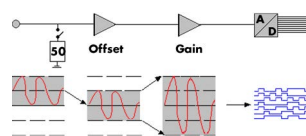

The analog inputs can be adapted to real world signals using a wide variety of settings that are individual for each channel. By using software commands one can select a matching input

range and the signal offset can be compensated.

### Automatic on-board calibration

All of the channels are calibrated in factory before the board is shipped. To compensate for different variations like PC power supply, temperature and aging, the software driver provides routines for an automatic onboard offset and gain calibration of all input ranges. All the cards contain a high precision on-board calibration reference.

### M5i.3321 Time Domain Response Optimization

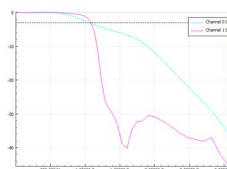

This option is only available for the M4i.3321-x16 (2 x 3.2 GS/s 12 Bit Digitizer with 1 GHz bandwidth). This option changes the hardware input filter of the card. The -inptd option optimizes the input stage for time domain measurement with a modified filter characteristic to minimize overshoot and undershoot on step response. The standard filter is optimized for frequency domain measurements with a very steep cut-off frequency. This steep cut-off frequency results in some overshoot/undershoot and ringing when feeding the system with step signals.

## Ring buffer mode

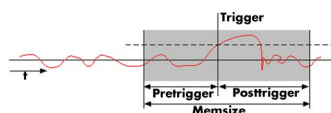

The ring buffer mode is the standard mode of all oscilloscope instruments. Digitized data is continuously written into a ring memory until a trigger event is detected. After the trigger, post-trigger samples are recorded and pre-trigger samples can also be stored. The number of pre-trigger samples available simply equals the total ring memory size minus the number of post trigger samples.

## FIFO mode

The FIFO or streaming mode is designed for continuous data transfer between the digitizer card and the PC memory. When mounted in a PCI Express x16 Gen 3 interface read streaming speeds of up to 12.8 GByte/s are possible. The maximum speed has been measured using a state-of-the-art motherboard with a PCIe payload size of 512. The control of the data stream is done automatically by the driver on interrupt request basis. The complete installed on-board memory is used to buffer the data, making the continuous streaming process extremely reliable.

## 8 bit Sample reduction (low-resolution) mode

The digitizer of the 33xx series allow to optionally reduce the resolution of the A/D samples from their native 12 bit resolution down to 8 bit resolution, such that each sample will only occupy one byte in memory instead of the standard two bytes required. This does not only enhance the size of the on-board memory from 2 GSamples (8 GSamples optionally) to effectively 4 GSamples (16 GSamples optionally), but also reduces the required bandwidth over the PCIe bus and also to the storage devices, such as SSD or HDD. Using the 8 bit mode it is possible to stream data over the PCIe bus with 10 GS/s continuously!

## Channel trigger

The digitizers offer a wide variety of trigger modes. These include a standard triggering mode based on a signals level and slope, like that found in most oscilloscopes. It is also possible to define a window mode, with two trigger levels, that enables triggering when signals enter or exit the window. Each input has its own trigger circuit which can be used to setup conditional triggers based on logical AND/OR patterns. All trigger modes can be combined with a re-arming mode for accurate trigger recognition even on noisy signals.

## External trigger input

All boards can be triggered using an external analog or digital signal. The external trigger input has one comparator that can be used for standard edge and level triggers.

## Multiple Recording

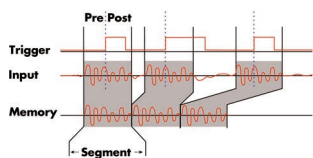

The Multiple Recording mode allows the recording of several trigger events with an extremely short re-arming time. The hardware doesn't need to be restarted in between. The on-board memory is divided in several segments of the same size. Each of them is filled with data if a trigger event occurs. Pre- and posttrigger of the segments can be programmed. The number of acquired segments is only limited by the used memory and is unlimited when using FIFO mode.

## Firmware Option Block Average

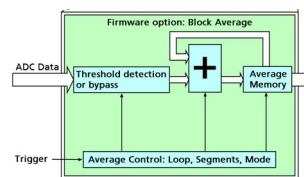

The Block Average Module improves the fidelity of noisy repetitive signals. Multiple repetitive acquisitions with very small dead-time are accumulated and averaged.

Random noise is reduced by the averaging process improving the visibility of the repetitive signal. Additionally, synchronous noise can be reduced with a sample selection based on threshold detection prior to accumulation, for applications such as time of flight mass spectrometry (TOFMS).

The complete averaging process is done inside the FPGA of the digitizer generating no CPU load at all. The amount of data is greatly decreased as well as the needed transfer bandwidth is heavily reduced.

## Timestamp

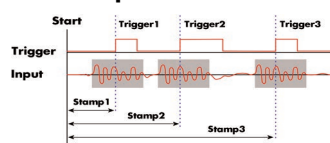

The timestamp function writes the time positions of the trigger events in an extra memory. The timestamps are relative to the start of recording, a defined zero time, externally synchronized to a radio clock, an IRIG-B or GPS receiver. Using the external synchronization gives a precise time relation for acquisitions of systems on different locations.

## External clock input and output

Using a dedicated connector a sampling clock can be fed in from an external system. Additionally it's also possible to output the internally used sampling clock on a separate connector to synchronize external equipment to this clock.

## Reference clock

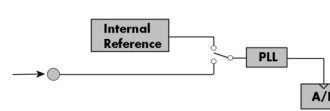

The option to use a precise external reference clock (normally 10 MHz) is necessary to synchronize the instrument for high-quality measurements with external equipment (like a signal source). It's also possible to enhance the quality of the sampling clock in this way. The driver automatically generates the requested sampling clock from the fed in reference clock.

## External Amplifiers



For the acquisition of extremely small voltage levels with a high bandwidth a series of external amplifiers is available. Each of the one channel amplifiers is working with a fixed input impedance and allows - depending on the bandwidth - to select different amplification levels between x10 (20 dB) up to x1000 (60 dB). Using the external amplifiers of the SPA series voltage levels in the  $\mu\text{V}$  and mV area can be acquired.

### **Firmware Option Digital Pulse Generator**

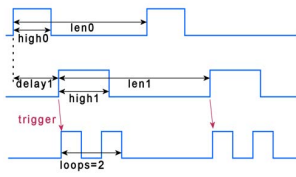

The digital pulse generator option adds 4 internal independent digital pulse generators with programmable duty cycle, output frequency, delay and number of loops.

These digital pulse generators can be triggered by software, hardware trigger or can trigger each other allowing to form complex pulse schemes to drive external equipment or experiments.

The digital pulse generators can be output on the existing multi-XIO lines (X0, X1, ...), to trigger other pulse generators or can be used to trigger the instrument's main trigger internally. Time resolution of the pulse generator depends on the cards type and the selected sampling rate and can be found in the technical data section.

The pulse generator option is a firmware option and can be later installed on all shipped cards.

### **Star-Hub**



The Star-Hub is an additional module allowing the phase stable synchronization of up to 8 boards of a kind in one system. Independent of the number of boards there is no phase delay between all channels. The Star-Hub distributes trigger and clock information between all boards to ensure all connected boards are running with the same clock and trigger. All trigger sources can be combined with a

logical OR allowing all channels of all cards to be the trigger source at the same time.

## Technical Data



Only figures that are given with a maximum reading or with a tolerance reading are guaranteed specifications. All other figures are typical characteristics that are given for information purposes only. Figures are valid for products stored for at least 2 hours inside the specified operating temperature range, after a 30 minute warm-up, after running an on-board calibration and with proper cooled products. All figures have been measured in lab environment with an environmental temperature between 20°C and 25°C and an altitude of less than 100 m.

### Analog Inputs

Resolution		12 bit (can be switched by software to 8 bit to reduce data throughput)
Input Range	software programmable	±200 mV, ±500 mV, ±1 V, ±2.5 V
Input Type	fixed	Single-ended
Input Offset (single-ended)	software programmable	programmable to ±100% of input range in steps of 1%
ADC Differential non linearity (DNL)	ADC only	±0.3 LSB
ADC Integral non linearity (INL)	ADC only	±2.5 LSB
Offset error (full speed), DC signal	after warm-up and calibration	< 0.5% of range
Gain error (full speed), DC signal	after warm-up and calibration	< 0.5% of reading
Crosstalk: Signal 10 MHz, 50 Ω	any range, any channel	< -110 dB
Crosstalk: Signal 100 MHz, 50 Ω	any range, any channel	< -103 dB
Analog Input impedance	fixed	50 Ω
Analog input coupling	fixed	DC
Over voltage protection	input range ±200 mV	1.4 Vrms (16 dBm), max ±2.0 V peak input voltage
Over voltage protection	input range >= ±500 mV	5 Vrms (27 dBm), max ±7.5 V peak input voltage
Anti-Aliasing Filter (standard)		fixed at specified bandwidth (see table below)
Channel selection (single-ended inputs)	software programmable	1 or 2 channels (maximum is model dependent)
Calibration	Internal	Self-calibration is done on software command and corrects against the on-board references. Self-calibration should be issued after warm-up time.
Calibration	External	External calibration calibrates the on-board references used in self-calibration. All calibration constants are stored in non-volatile memory. A yearly external calibration is recommended.

	Input Range	M5i.3360-x16 M5i.3367-x16	M5i.3350-x16 M5i.3357-x16	M5i.3330-x16 M5i.3337-x16	M5i.3321-x16
lower bandwidth limit	all ranges	0 Hz (DC)	0 Hz (DC)	0 Hz (DC)	0 Hz (DC)
-3 dB bandwidth (minimum)	all ranges	4.7 GHz	3.0 GHz	2.0 GHz	1.0 GHz
-3 dB bandwidth (typical)	all ranges	4.8 GHz	3.1 GHz	2.2 GHz	1.1 GHz
Flatness within ±0.5 dB	all ranges	2.0 GHz	1.8 GHz	1.1 GHz	0.8 GHz

### Trigger

Available trigger modes	software programmable	Channel Trigger, External, Software, Window, Re-Arm, Or/And, Delay
Channel trigger level resolution		12 bit
Trigger edge	software programmable	Rising edge, falling edge or both edges
Trigger delay	software programmable	0 up to (256 GS - 32) in steps of 32
Trigger holdoff (for Multi)	software programmable	0 up to (256 GS - 32) in steps of 32
Multi re-arming time	1 channel mode 2 channel mode	352 samples (+ programmed pretrigger) 176 samples (+ programmed pretrigger)
Pretrigger at Multi, FIFO	software programmable	32 up to (32 kSamples / channels) in steps of 32
Posttrigger at Standard Single	software programmable	32 up to (256 GS - 32) in steps of 32
Memory depth	software programmable	64 up to (Installed memory / channels) in steps of 32
Multiple Recording segment size	software programmable	64 up to (Installed memory / channels) in steps of 32
Internal/External trigger accuracy		1 sample
Timestamp modes	software programmable	Standard, Startreset, external reference clock (e.g. PPS from GPS, IRIG-B)
Data format		Std., Startreset: 64 bit counter, increments with sample clock (reset manually or on start) RefClock: 24 bit upper counter (increment with RefClock) 40 bit lower counter (increments with sample clock, reset with RefClock)
Extra data	software programmable	none, acquisition of X0/X1/X2/X3 inputs at trigger time, trigger source (for OR trigger)
Size per stamp		128 bit = 16 bytes
External trigger		<b>Ext</b>
External trigger type		single level comparator
External trigger impedance	software programmable	50 Ω or 3k Ω
External trigger input level		±5 V
External trigger over voltage protection	50 Ω termination 3k Ω termination	±20 V 7 Vrms
External trigger sensitivity (minimum required signal swing)		200 mVpp
External trigger level	software programmable	±5 V with a stepsize of 10 mV
External trigger bandwidth	50 Ω 3 kΩ 10 kΩ	DC to 2 GHz DC to 750 MHz n.a.
Minimum external trigger pulse width		≥ 2 samples
Resulting max detectable trigger frequency		[Current Samplerate]/2
		<b>X0, X1, X2, X3</b>
		3.3V LVTTTL logic inputs
		For electrical specifications refer to „Multi Purpose I/O lines“ section.
		DC to 125 MHz n.a. DC to 125 MHz
		≥ 2 samples
		[Current Samplerate]/2

## Multi Purpose I/O lines (front-plate)

Number of multi purpose lines		four, named X0, X1, X2, X3
Input: available signal types	software programmable	Logic Trigger, Asynchronous Digital-In, Synchronous Digital-In, Timestamp Reference Clock
Input: impedance	software programmable	10 k $\Omega$ to 3.3 V or 50 $\Omega$ to GND
Input: maximum voltage level		-0.5 V to +4.0 V
Input: signal levels		3.3 V LVTTTL (Low $\leq$ 0.8 V, High $\geq$ 2.0 V)
Input: bandwidth		125 MHz
Output: available signal types	software programmable	Asynchronous Digital-Out, Trigger Output, Run, Arm, System Clock
Output: impedance		50 $\Omega$
Output: signal levels		3.3 V LVTTTL
Output: type		3.3V LVTTTL, TTL compatible for high impedance loads
Output: drive strength		Capable of driving 50 $\Omega$ loads, maximum drive strength $\pm$ 48 mA
Output: internal update rate	M5i.33xx	Current sampling clock $\leq$ 3.2 GS/s : 1/4 of sampling clock Current sampling clock $>$ 3.2 GS/s and $\leq$ 6.4 GS/s : 1/8 of sampling clock
Output: min high/low time		4 ns
Output: max signal frequency		125 MHz

## Option M5i.xxxx-PulseGen

Number of internal pulse generators		4
Number of pulse generator output lines		4 (Existing multi-purpose outputs X0 to X3)
Time resolution of pulse generator		Pulse generator's sampling rate is derived from instrument's sampling rate and value can be read out. Maximum possible pulse generator update rate is 33xx: 312.5 MS/s (3.2 ns)
Programmable output modes		Single-shot, multiple repetitions on trigger, gated
Programmable trigger sources		Software, Card Trigger, Other Pulse Generator, XIO lines.
Programmable trigger gate		None, ARM state, RUN state
Programmable length (frequency)		2 to 4G samples in steps of 1 (32 bit)
Programmable width (duty cycle)		1 to 4G samples in steps of 1 (32 bit)
Programmable delay		0 to 4G samples in steps of 1 (32 bit)
Programmable loops		0 to 4G samples in steps of 1 (32 bit) - 0 = infinite
Output level of digital pulse generators		Please see section of multi-purpose I/O lines

## Clock

Clock Modes	software programmable	internal PLL, external reference clock, star-hub synchronization clock
Internal clock accuracy		$\leq \pm 1$ ppm
Clock setup range		base frequency or divided base frequency
Clock setup base frequencies	M5i.3321 M5i.333x M5i.335x/M5i.336x	3.2 GS/s, 2.5 GS/s, 2.0 GS/s 6.4 GS/s, 5.0 GS/s, 4.0 GS/s 10.0 GS/s, 8.0 GS/s, 5.0 GS/s
Clock setup divider		power of 2: 2, 4, 8, 16, 32, ..., 524288, 1048576
Clock setup examples	M5i.332x M5i.333x M5i.335x/M5i.336x	Combination of any base frequency with any divider: 3.2, 2.5, 2.0, 1.6, 1.25, 1.0, 0.8 GS/s, ..., 1 kS/s 6.4, 5.0, 4.0, 3.2, 2.5, 2.0, 1.6, 1.25, 1.0, 0.8 GS/s, ..., 1 kS/s 10.0, 8.0, 6.4, 5.0, 4.0, 3.2, 2.5, 2.0, 1.6, 1.25, 1.0 GS/s, ..., 1 kS/s
External reference clock range	software programmable	$\geq 2$ MHz and $\leq 750$ MHz in steps of 2 MHz
External reference clock input impedance		50 $\Omega$ fixed
External reference clock input coupling		AC coupling
External reference clock input edge		Rising edge
External reference clock input type		Single-ended, sine wave or square wave
External reference clock input swing	min max	200 mVpp 3 Vpp
External reference clock input max DC voltage		$\pm 10$ V (with max 3.0 V difference between low and high level)
External reference clock input duty cycle requirement		45% to 55%
Clock setup granularity when using reference clock		divider: maximum sampling rate divided by: TBD
Internal reference clock output type		Single-ended, AC-coupled, LVPECL, 720 mVpp (typ)
Internal reference clock output frequency	M5i.3321 M5i.333x/335x/336x	clock setup base frequency / 64 (example: clock 3.2 GS/s -> output 50.000 MHz) clock setup base frequency / 128 (example: clock 4.0 GS/s -> output 31.25 MHz)
Star-Hub synchronization clock modes	software programmable	Internal clock, External reference clock
Channel to channel skew on one card		$< 12$ ps
Skew between star-hub synchronized cards	software programmable	skew adjustable up to 200 ps (10 GS/s models) or 312 ps (6.4 GS/s and 3.2 GS/s models)

## Block Average Signal Processing Option M5i.33xx

Averaging/Accumulation Modes	Software programmable	Standard or threshold defined averaging (TDA) for positive or negative pulses
Minimum Waveform Length		64 samples
Minimum Waveform Stepsize		32 samples
Maximum Waveform Length	1 channel active	1 MSamples
Maximum Waveform Length	2 channels active	512 kSamples
Minimum Number of Averages		2
Maximum Number of Averages		1024 (1k)
Data Output Format	fixed	32 bit signed integer
Re-Arming Time between waveforms	1 channel mode	352 samples (+ programmed pretrigger)
	2 channel mode	176 samples (+ programmed pretrigger)
Re-Arming Time between end of average to start of next average		Two times the programmed segment length's (L) acquisition time: $t = 2 * \text{SegmentLen} * \text{ActiveChannels} / \text{Samplerate}$

## Connectors

Analog Inputs (one for each single-ended input)	SMA female	Cable-Type: Cab-3mA-xx-xx
Trigger Input	SMA female	Cable-Type: Cab-3mA-xx-xx
Clock Input	SMA female	Cable-Type: Cab-3mA-xx-xx
Clock Output	SMA female	Cable-Type: Cab-3mA-xx-xx
Multi Purpose I/O	SMA female	Cable-Type: Cab-3mA-xx-xx
Power Connector	PCIe 6-pin power +12V+GND	Must be supplied by PC power supply

## Connection Cycles

All connectors have an expected lifetime as specified below. Please avoid to exceed the specified connection cycles or use connector savers.

SMA connector	500 connection cycles
PCIe connector	50 connection cycles
PCIe power connector	30 connection cycles

## Environmental and Physical Details

Dimension (Card, including rear fans)		L x H x W: 241 mm x 107 mm x 40 mm (double slot width)
Dimension (Card, rear fans, option star-hub)		L x H x W: 241 mm x 107 mm x 60 mm (three slots width)
Weight (M5i.33xx series)	maximum	780 g
Weight (Option Star-hub, including 8 cables)	maximum	150 g
Warm up time		30 minutes (running acquisition at full speed)
Operating temperature		0°C to 50°C
Storage temperature		-10°C to 70°C
Humidity		10% to 90%
Dimension of packing	1 card	470 mm x 250 mm x 130 cm
Volume weight of packing	1 card	4 kg

## PCI Express specific details

PCIe connector type	x16 Generation 3 (Gen3)
PCIe slot compatibility (physical)	x16
PCIe slot compatibility (electrical)	x1, x2, x4, x8, x16 with PCIe Gen1, Gen2, Gen3, Gen4 or Gen5
Sustained streaming mode (Card-to-System):	> 12.8 GB/s (measured on PCIe x16 Gen3 with a chipset supporting a 512 bytes TLP) > 11.2 GB/s (measured on PCIe x16 Gen3 with a chipset supporting a 256 bytes TLP)
PCIe max card controller TLP	512 (lower values will limit maximum streaming speed)

## Certification, Compliance, Warranty

Conformity Declaration	EN 17050-1:2010	General Requirements
EU Directives	2014/30/EU 2014/35/EU 2011/65/EU 2006/1907/EC 2012/19/EU	EMC - Electromagnetic Compatibility LVD - Electrical equipment designed for use within certain voltage limits RoHS - Restriction of the use of certain hazardous substances in electrical and electronic equipment REACH - Registration, Evaluation, Authorisation and Restriction of Chemicals WEEE - Waste from Electrical and Electronic Equipment
Compliance Standards	EN 61010-1: 2010 EN 61187:1994 EN 61326-1:2021 EN 61326-2-1:2021  EN IEC 63000:2018	Safety regulations for electrical measuring, control, regulating and laboratory devices - Part 1: General requirement Electrical and electronic measuring equipment - Documentation Electrical equipment for measurement, control and laboratory use EMC requirements - Part 1: General requirements EMC requirements - Part 2-1: Particular requirements - Test configurations, operational conditions and performance criteria for sensitive test and measurement equipment for EMC unprotected applications Technical documentation for the assessment of electrical and electronic products with respect to the restriction of hazardous substances
Product warranty	5 years starting with the day of delivery	
Software and firmware updates	Life-time, free of charge	

## Power Consumption

	Bus Connector		Power Connector*		Total
	3.3V	12 V	12 V		
M5i.3357-x16/M5i.3367-x16	0.3 A	n.a.	3.2 A		39 W
M5i.3350-x16/M5i.3360-x16	0.3 A	n.a.	3.0 A		37 W
M5i.3337-x16	0.3 A	n.a.	3.0 A		37 W
M5i.3330-x16	0.3 A	n.a.	2.8 A		35 W
M5i.3321-x16	0.3 A	n.a.	3.0 A		37 W

\*A separate power connection to the card is mandatory. The card cannot be powered solely by the PCIe bus connector

## MTBF

MTBF	TBD hours
------	-----------

## Frequency Response Plots

### Frequency Response M5i.3360-x16, M5i.3367-x16

Sampling Rate: 10 GS/s, Bandwidth 4.7 GHz  
50  $\Omega$ , DC coupling, no offset, no external filter

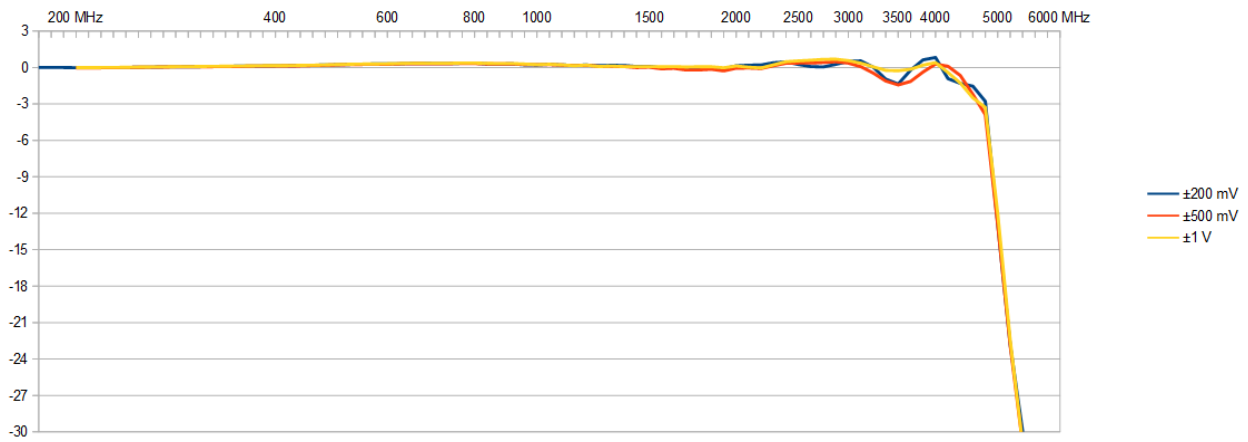

### Frequency Response M5i.3350-x16, M5i.3357-x16

Sampling Rate: 10 GS/s, Bandwidth 3.0 GHz  
50  $\Omega$ , DC coupling, no offset, no external filter

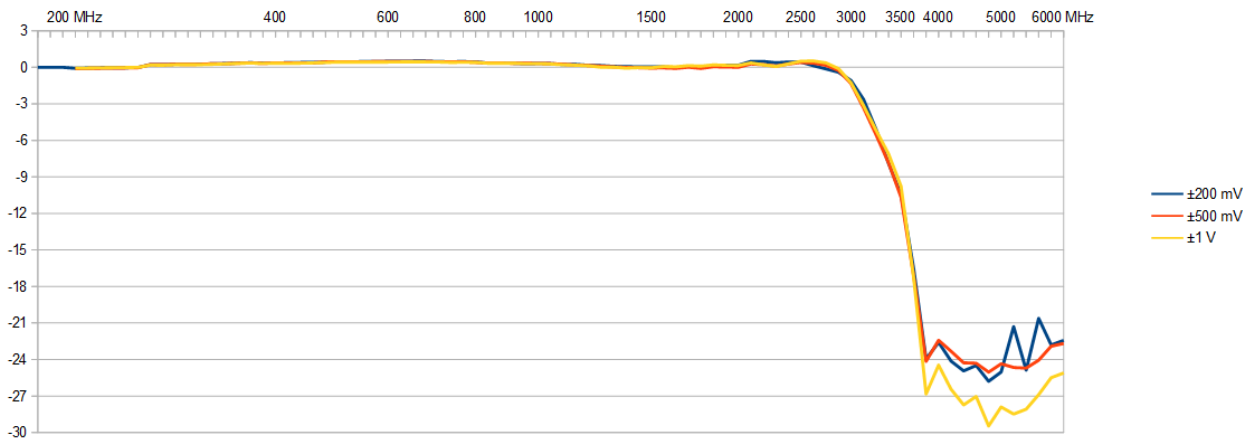

### Frequency Response M5i.3330-x16, M5i.3337-x16

Sampling Rate: 6.4 GS/s, Bandwidth 2.0 GHz  
50  $\Omega$ , DC coupling, no offset, no external filter

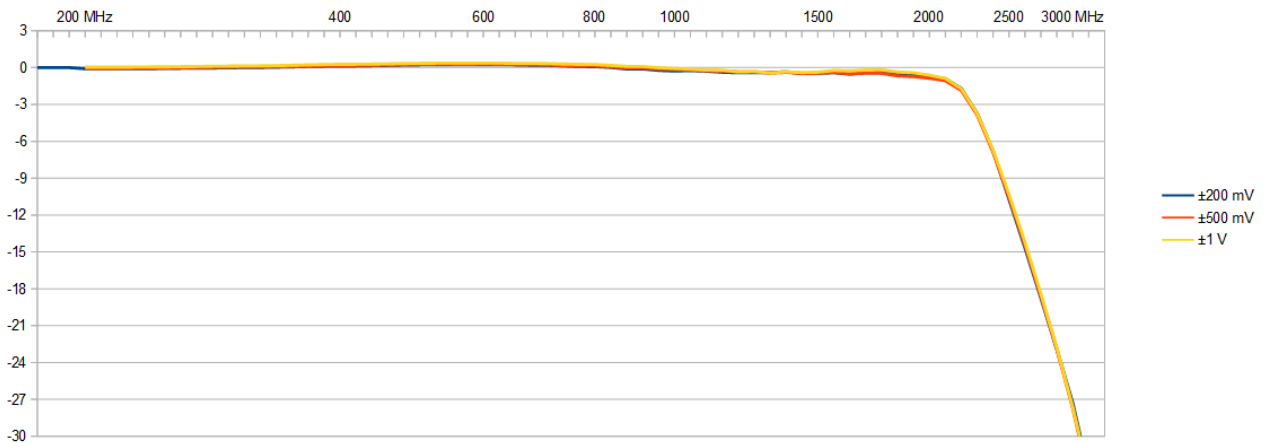



### Frequency Response M5i.3321-x16 Standard

Sampling Rate: 3.2 GS/s, Bandwidth 1.0 GHz  
50  $\Omega$ , DC coupling, no offset, no external filter  
Standard Filter

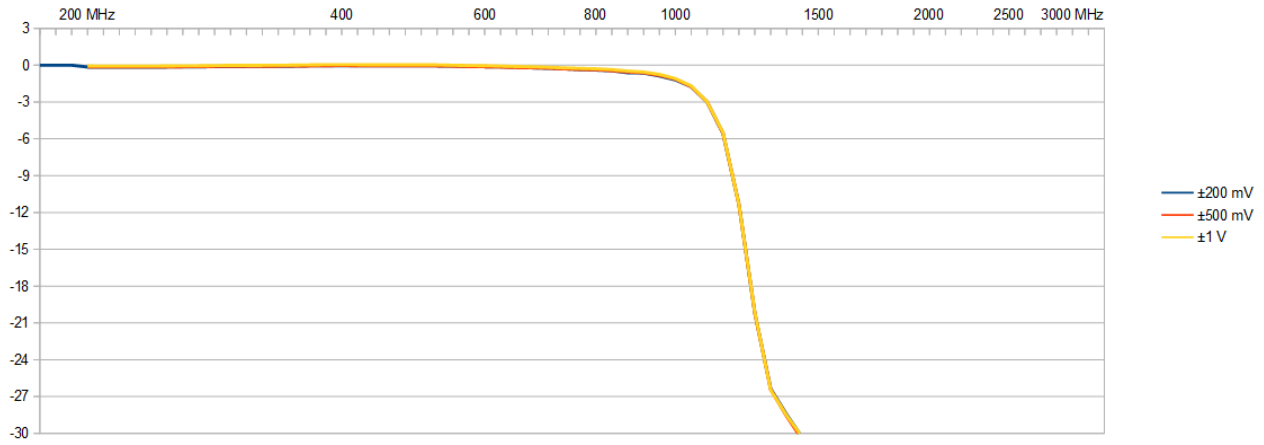

### Frequency Response M5i.3321-x16 with option -inptd

Sampling Rate: 3.2 GS/s, Bandwidth 1.0 GHz  
50  $\Omega$ , DC coupling, no offset, no external filter  
Option -inptd (input time domain optimization) Filter

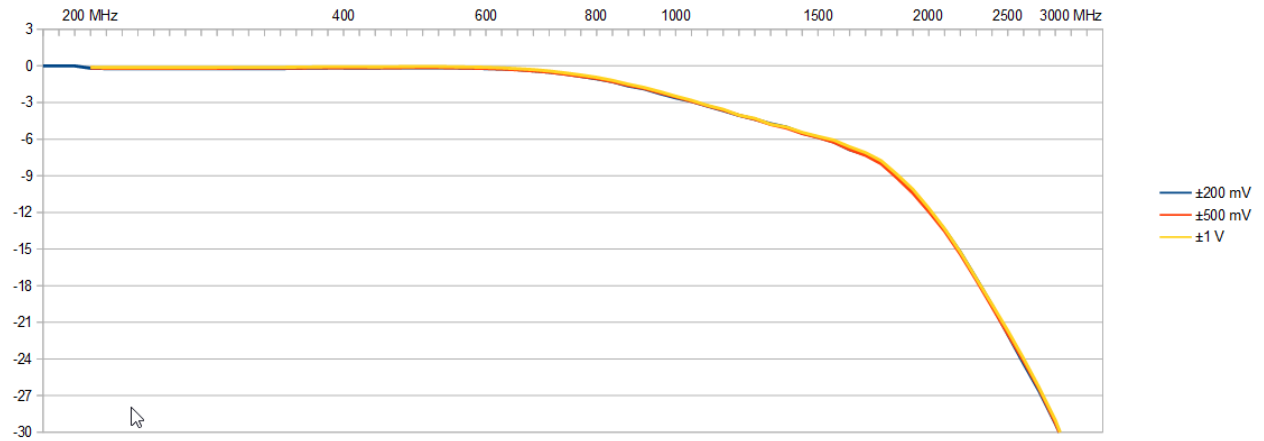

## Dynamic Parameters 10.0 GS/s 4.7 GHz models

		M5i.3360-x16 and M5i.3367-x16 - 12 Bit 10 GS/s (channel 0)											
Input Range		±200 mV						±500 mV					
Test signal frequency		10 MHz	40 MHz	70 MHz	240 MHz	600 MHz	1.2 GHz	10 MHz	40 MHz	70 MHz	240 MHz	600 MHz	1.2 GHz
SNR (typ)		50.9 dB	50.3 dB	50.6 dB	50.0 dB	50.4 dB	50.9 dB	51.8 dB	51.5 dB	51.2 dB	50.9 dB	51.4 dB	50.8 dB
THD (typ)		-65.9 dB	-67.4 dB	-69.6 dB	-60.0 dB	-53.7 dB	-57.4 dB	-70.6 dB	-69.1 dB	-65.5 dB	-61.4 dB	-58.8 dB	-57.8 dB
SFDR (typ), incl. harm.		59.7 dB	57.6 dB	59.6 dB	58.1 dB	55.1 dB	57.9 dB	61.2 dB	59.3 dB	58.8 dB	58.2 dB	60.5 dB	58.4 dB
SFDR (typ), excl. harm.		59.7 dB	57.6 dB	59.6 dB	58.1 dB	60.7 dB	61.4 dB	61.2 dB	59.3 dB	58.8 dB	58.2 dB	63.9 dB	60.1 dB
SINAD/THD+N (typ)		50.8 dB	50.3 dB	50.6 dB	49.6 dB	48.7 dB	50.0 dB	51.7 dB	51.4 dB	51.1 dB	50.6 dB	50.7 dB	50.0 dB
ENOB (SINAD)		8.2 LSB	8.1 LSB	8.1 LSB	8.0 LSB	7.8 LSB	8.0 LSB	8.3 LSB	8.2 LSB	8.2 LSB	8.1 LSB	8.1 LSB	8.0 LSB
ENOB (SNR)		8.2 LSB	8.1 LSB	8.1 LSB	8.0 LSB	8.1 LSB	8.2 LSB	8.3 LSB	8.3 LSB	8.2 LSB	8.1 LSB	8.2 LSB	8.1 LSB

		M5i.3360-x16 and M5i.3367-x16 - 12 Bit 10 GS/s (channel 0)											
Input Range		±1 V						±2.5 V					
Test signal frequency		10 MHz	40 MHz	70 MHz	240 MHz	600 MHz	1.2 GHz	10 MHz	40 MHz	70 MHz	240 MHz	600 MHz	1.2 GHz
SNR (typ)		51.3 dB	51.4 dB	51.3 dB	51.0 dB	51.3 dB	50.9 dB	51.3 dB	51.4 dB	51.3 dB	51.0 dB	51.3 dB	50.9 dB
THD (typ)		-70.0 dB	-67.3 dB	-68.9 dB	-61.1 dB	-58.3 dB	-57.4 dB	-70.0 dB	-67.3 dB	-68.9 dB	-61.1 dB	-58.3 dB	-57.4 dB
SFDR (typ), incl. harm.		59.4 dB	60.4 dB	58.9 dB	58.9 dB	59.1 dB	57.9 dB	59.4 dB	60.4 dB	58.9 dB	58.9 dB	59.1 dB	57.9 dB
SFDR (typ), excl. harm.		59.4 dB	60.4 dB	58.9 dB	58.9 dB	62.3 dB	61.4 dB	59.4 dB	60.4 dB	58.9 dB	58.9 dB	62.3 dB	61.4 dB
SINAD/THD+N (typ)		51.3 dB	51.3 dB	51.1 dB	50.6 dB	50.6 dB	50.1 dB	51.3 dB	51.3 dB	51.1 dB	50.6 dB	50.6 dB	50.1 dB
ENOB (SINAD)		8.2 LSB	8.2 LSB	8.2 dB	8.1 LSB	8.1 LSB	8.0 LSB	8.2 LSB	8.2 LSB	8.2 dB	8.1 LSB	8.1 LSB	8.0 LSB
ENOB (SNR)		8.2 LSB	8.2 LSB	8.2 dB	8.2 LSB	8.2 LSB	8.2 LSB	8.2 LSB	8.2 LSB	8.2 dB	8.2 LSB	8.2 LSB	8.2 LSB

## Dynamic Parameters 10.0 GS/s 3.0 GHz models

		M5i.3350-x16 and M5i.3357-x16 - 12 Bit 10 GS/s (channel 0)											
Input Range		±200 mV						±500 mV					
Test signal frequency		10 MHz	40 MHz	70 MHz	240 MHz	600 MHz	1.2 GHz	10 MHz	40 MHz	70 MHz	240 MHz	600 MHz	1.2 GHz
SNR (typ)		51.5 dB	52.0 dB	51.3 dB	51.0 dB	50.9 dB	50.8 dB	52.0 dB	52.0 dB	51.2 dB	52.3 dB	51.5 dB	51.3 dB
THD (typ)		-66.8 dB	-65.3 dB	-65.2 dB	-65.4 dB	-55.7 dB	-54.8 dB	-65.5 dB	-63.1 dB	-65.9 dB	-65.2 dB	-58.6 dB	-58.8 dB
SFDR (typ), incl. harm.		56.0 dB	55.7 dB	54.6 dB	54.8 dB	55.6 dB	55.0 dB	55.7 dB	64.7 dB	54.3 dB	58.9 dB	59.6 dB	52.5 dB
SFDR (typ), excl. harm.		56.0 dB	55.7 dB	54.6 dB	54.8 dB	55.6 dB	55.6 dB	55.7 dB	67.0 dB	54.3 dB	58.9 dB	59.6 dB	52.5 dB
SINAD/THD+N (typ)		51.3 dB	51.8 dB	51.2 dB	50.9 dB	49.6 dB	49.4 dB	51.8 dB	51.9 dB	51.1 dB	52.2 dB	50.7 dB	49.2 dB
ENOB (SINAD)		8.2 LSB	8.3 LSB	8.2 LSB	8.2 LSB	8.0 LSB	7.9 LSB	8.3 LSB	8.3 LSB	8.2 LSB	8.4 LSB	8.1 LSB	7.9 LSB
ENOB (SNR)		8.3 LSB	8.3 LSB	8.2 LSB	8.2 LSB	8.2 LSB	8.0 LSB	8.3 LSB	8.3 LSB	8.2 LSB	8.4 LSB	8.2 LSB	8.2 LSB

		M5i.3350-x16 and M5i.3357-x16 - 12 Bit 10 GS/s (channel 0)											
Input Range		±1 V						±2.5 V					
Test signal frequency		10 MHz	40 MHz	70 MHz	240 MHz	600 MHz	1.2 GHz	10 MHz	40 MHz	70 MHz	240 MHz	600 MHz	1.2 GHz
SNR (typ)		51.7 dB	52.0 dB	51.7 dB	51.6 dB	51.2 dB	51.2 dB	52.0 dB	52.0 dB	51.2 dB	52.3 dB	51.5 dB	51.0 dB
THD (typ)		-66.4 dB	-66.5 dB	-66.5 dB	-64.7 dB	-58.5 dB	-60.5 dB	-65.5 dB	-63.1 dB	-65.9 dB	-65.2 dB	-58.6 dB	-64.4 dB
SFDR (typ), incl. harm.		55.8 dB	63.6 dB	55.9 dB	54.9 dB	59.5 dB	57.7 dB	55.7 dB	64.7 dB	54.3 dB	58.9 dB	59.6 dB	60.4 dB
SFDR (typ), excl. harm.		55.8 dB	63.7 dB	55.9 dB	54.9 dB	60.0 dB	57.7 dB	55.7 dB	67.0 dB	54.3 dB	58.9 dB	59.6 dB	60.4 dB
SINAD/THD+N (typ)		51.6 dB	51.9 dB	51.7 dB	51.5 dB	50.5 dB	51.2 dB	51.8 dB	51.9 dB	51.1 dB	52.2 dB	50.7 dB	50.9 dB
ENOB (SINAD)		8.3 LSB	8.3 LSB	8.3 dB	8.3 LSB	8.1 LSB	8.2 LSB	8.3 LSB	8.3 LSB	8.2 LSB	8.4 LSB	8.1 LSB	8.1 LSB
ENOB (SNR)		8.3 LSB	8.3 LSB	8.3 dB	8.3 LSB	8.2 LSB	8.2 LSB	8.3 LSB	8.3 LSB	8.2 LSB	8.4 LSB	8.2 LSB	8.2 LSB

## Dynamic Parameters 6.4 GS/s models

		M5i.3330-x16 and M5i.3337-x16 - 12 Bit 6.4 GS/s (channel 0)											
Input Range		±200 mV						±500 mV					
Test signal frequency		10 MHz	40 MHz	70 MHz	240 MHz	600 MHz	1.2 GHz	10 MHz	40 MHz	70 MHz	240 MHz	600 MHz	1.2 GHz
SNR (typ)		53.1 dB	53.1 dB	53.0 dB	52.6 dB	51.9 dB	50.1 dB	53.8 dB	53.2 dB	53.4 dB	53.0 dB	52.4 dB	50.3 dB
THD (typ)		-63.8 dB	-63.8 dB	-62.0 dB	-62.3 dB	-56.9 dB	-56.7 dB	-61.6 dB	-62.1 dB	-61.6 dB	-61.6 dB	-59.8 dB	-59.8 dB
SFDR (typ), incl. harm.		62.0 dB	61.6 dB	62.4 dB	62.5 dB	59.7 dB	57.2 dB	62.5 dB	64.2 dB	60.7 dB	62.2 dB	58.1 dB	60.0 dB
SFDR (typ), excl. harm.		62.0 dB	61.6 dB	62.6 dB	62.6 dB	64.5 dB	58.7 dB	65.0 dB	66.3 dB	60.6 dB	65.1 dB	58.1 dB	60.1 dB
SINAD/THD+N (typ)		52.8 dB	52.6 dB	52.3 dB	52.5 dB	51.6 dB	49.6 dB	53.4 dB	53.6 dB	52.8 dB	53.0 dB	51.9 dB	50.0 dB
ENOB (SINAD)		8.5 LSB	8.5 LSB	8.4 LSB	8.4 LSB	8.3 LSB	8.0 LSB	8.6 LSB	8.6 LSB	8.5 LSB	8.6 LSB	8.3 LSB	8.0 LSB
ENOB (SNR)		8.5 LSB	8.6 LSB	8.6 LSB	8.5 LSB	8.3 LSB	8.0 LSB	8.7 LSB	8.6 LSB	8.6 LSB	8.6 LSB	8.5 LSB	8.0 LSB

		M5i.3330-x16 and M5i.3337-x16 - 12 Bit 6.4 GS/s (channel 0)											
Input Range		±1 V						±2.5 V					
Test signal frequency		10 MHz	40 MHz	70 MHz	240 MHz	600 MHz	1.2 GHz	10 MHz	40 MHz	70 MHz	240 MHz	600 MHz	1.2 GHz
SNR (typ)		53.4 dB	53.6 dB	53.3 dB	53.4 dB	52.5 dB	50.3 dB	53.5 dB	52.9 dB	53.5 dB	53.4 dB	51.9 dB	52.3 dB
THD (typ)		-63.8 dB	-63.5 dB	-63.5 dB	-62.6 dB	-59.9 dB	-59.7 dB	-64.0 dB	-61.0 dB	-61.2 dB	-60.9 dB	-58.9 dB	-59.5 dB
SFDR (typ), incl. harm.		62.0 dB	63.3 dB	65.1 dB	58.1 dB	60.4 dB	53.0 dB	62.2 dB	60.9 dB	63.6 dB	62.2 dB	58.7 dB	58.8 dB
SFDR (typ), excl. harm.		62.0 dB	63.4 dB	66.3 dB	58.1 dB	60.8 dB	53.0 dB	62.2 dB	53.9 dB	63.5 dB	63.0 dB	59.4 dB	58.9 dB
SINAD/THD+N (typ)		53.0 dB	53.2 dB	53.1 dB	52.6 dB	51.8 dB	49.6 dB	53.1 dB	52.9 dB	53.1 dB	52.9 dB	51.6 dB	51.5 dB
ENOB (SINAD)		8.5 LSB	8.5 LSB	8.6 LSB	8.4 LSB	8.3 LSB	8.0 LSB	8.5 LSB	8.5 LSB	8.6 LSB	8.5 LSB	8.3 LSB	8.3 LSB
ENOB (SNR)		8.6 LSB	8.6 LSB	8.6 LSB	8.6 LSB	8.5 LSB	8.1 LSB	8.6 LSB	8.6 LSB	8.6 LSB	8.6 LSB	8.3 LSB	8.4 LSB

## Dynamic Parameters 3.2 GS/s models

M5i.3321-x16 - 12 Bit 3.2 GS/s											
Input Range	±200 mV						±500 mV				
Test signal frequency	10 MHz	40 MHz	70 MHz	240 MHz	600 MHz		10 MHz	40 MHz	70 MHz	240 MHz	600 MHz
SNR (typ)	54.1 dB	54.4 dB	54.7 dB	54.5 dB	54.5 dB		54.8 dB	55.0 dB	54.8 dB	54.6 dB	54.9 dB
THD (typ)	-64.3 dB	-63.4 dB	-62.3 dB	-61.1 dB	-59.5 dB		-61.5 dB	-62.0 dB	-66.5 dB	-61.7 dB	-57.5 dB
SFDR (typ), incl. harm.	64.7 dB	65.4 dB	63.5 dB	61.9 dB	61.8 dB		72.9 dB	64.9 dB	65.6 dB	62.1 dB	60.3 dB
SFDR (typ), excl. harm.	65.1 dB	73.8 dB	71.6 dB	72.5 dB	69.7 dB		65.6 dB	72.8 dB	65.8 dB	69.1 dB	67.7 dB
SINAD/THD+N (typ)	53.7 dB	53.9 dB	54.0 dB	53.6 dB	53.3 dB		54.0 dB	54.2 dB	54.6 dB	53.9 dB	52.9 dB
ENOB (SINAD)	8.6 LSB	8.7 LSB	8.7 LSB	8.5 LSB	8.6 LSB		8.7 LSB	8.7 LSB	8.8 LSB	8.7 LSB	8.5 LSB
ENOB (SNR)	8.7 LSB	8.7 LSB	8.8 LSB	8.8 LSB	8.8 LSB		8.8 LSB	8.8 LSB	8.8 LSB	8.8 LSB	8.8 LSB

M5i.3321-x16 - 12 Bit 3.2 GS/s											
Input Range	±1 V						±2.5 V				
Test signal frequency	10 MHz	40 MHz	70 MHz	240 MHz	600 MHz		10 MHz	40 MHz	70 MHz	240 MHz	600 MHz
SNR (typ)	55.3 dB	55.3 dB	54.8 dB	54.8 dB	54.9 dB		54.8 dB	55.3 dB	54.8 dB	54.8 dB	54.9 dB
THD (typ)	-63.8 dB	-63.8 dB	-59.5 dB	-62.5 dB	-57.8 dB		-63.4 dB	-63.8 dB	-59.5 dB	-62.5 dB	-57.8 dB
SFDR (typ), incl. harm.	64.5 dB	66.3 dB	60.7 dB	63.5 dB	60.4 dB		62.5 dB	66.3 dB	60.7 dB	63.5 dB	60.4 dB
SFDR (typ), excl. harm.	65.3 dB	73.2 dB	67.4 dB	71.0 dB	68.9 dB		62.7 dB	73.2 dB	67.4 dB	71.0 dB	68.9 dB
SINAD/THD+N (typ)	54.2 dB	54.8 dB	53.6 dB	54.1 dB	53.1 dB		54.2 dB	54.8 dB	53.6 dB	54.1 dB	53.1 dB
ENOB (SINAD)	8.7 LSB	8.8 LSB	8.6 LSB	8.7 LSB	8.5 LSB		8.7 LSB	8.8 LSB	8.6 LSB	8.7 LSB	8.5 LSB
ENOB (SNR)	8.9 LSB	8.9 LSB	8.8 LSB	8.8 LSB	8.8 LSB		8.8 LSB	8.9 LSB	8.8 LSB	8.8 LSB	8.8 LSB

## Dynamic Parameters 10.0 GS/s 4.7 GHz models (8-bit Mode)

The below dynamic parameters are measured using the 8-bit mode which reduces the resolution in hardware from 12 bit to 8 bit to save memory and data transfer bandwidth. Due to the hardware resolution being below the ENOB of all models, the dynamic parameters are similar for all models when switched to the 8-bit mode.

M5i.3360-x16 and M5i.3367-x16 - 8 Bit 10 GS/s (channel 0)												
Input Range	±200 mV						±500 mV					
Test signal frequency	10 MHz	40 MHz	70 MHz	240 MHz	600 MHz	1.2 GHz	10 MHz	40 MHz	70 MHz	240 MHz	600 MHz	1.2 GHz
SNR (typ)	46.8 dB	46.7 dB	46.6 dB	46.5 dB	46.5 dB	46.3 dB	46.8 dB	47.0 dB	46.8 dB	46.8 dB	46.9 dB	46.7 dB
THD (typ)	-65.2 dB	-66.1 dB	-67.0 dB	-60.6 dB	-54.3 dB	-54.0 dB	-65.4 dB	-66.2 dB	-65.3 dB	-60.6 dB	-58.9 dB	-56.7 dB
SFDR (typ), incl. harm.	55.3 dB	54.0 dB	55.2 dB	56.8 dB	55.6 dB	55.0 dB	56.1 dB	57.0 dB	53.5 dB	54.3 dB	56.2 dB	56.7 dB
SFDR (typ), excl. harm.	55.3 dB	54.0 dB	55.2 dB	56.8 dB	55.6 dB	56.4 dB	56.1 dB	57.0 dB	53.5 dB	55.3 dB	56.2 dB	56.7 dB
SINAD/THD+N (typ)	46.8 dB	46.7 dB	46.6 dB	46.3 dB	46.0 dB	45.7 dB	46.9 dB	47.0 dB	46.7 dB	46.7 dB	46.7 dB	46.5 dB
ENOB (SINAD)	7.5 LSB	7.5 LSB	7.5 LSB	7.4 LSB	7.4 LSB	7.3 LSB	7.5 LSB	7.5 LSB	7.5 LSB	7.5 LSB	7.5 LSB	7.4 LSB
ENOB (SNR)	7.5 LSB	7.5 LSB	7.5 LSB	7.4 LSB	7.4 LSB	7.4 LSB	7.5 LSB	7.5 LSB	7.5 LSB	7.5 LSB	7.5 LSB	7.5 LSB

M5i.3360-x16 and M5i.3367-x16 - 8 Bit 10 GS/s (channel 0)												
Input Range	±1 V						±2.5 V					
Test signal frequency	10 MHz	40 MHz	70 MHz	240 MHz	600 MHz	1.2 GHz	10 MHz	40 MHz	70 MHz	240 MHz	600 MHz	1.2 GHz
SNR (typ)	47.0 dB	46.9 dB	46.9 dB	46.8 dB	46.9 dB	46.7 dB	46.8 dB	47.0 dB	46.8 dB	46.8 dB	46.9 dB	46.7 dB
THD (typ)	-65.6 dB	-65.8 dB	-66.5 dB	-61.9 dB	-58.9 dB	-57.9 dB	-65.4 dB	-66.2 dB	-65.3 dB	-60.6 dB	-58.9 dB	-56.7 dB
SFDR (typ), incl. harm.	56.1 dB	55.2 dB	55.2 dB	55.9 dB	54.7 dB	56.2 dB	56.1 dB	57.0 dB	53.5 dB	54.3 dB	56.2 dB	56.7 dB
SFDR (typ), excl. harm.	56.1 dB	55.2 dB	55.2 dB	55.9 dB	54.7 dB	56.2 dB	56.1 dB	57.0 dB	53.5 dB	55.3 dB	56.2 dB	56.7 dB
SINAD/THD+N (typ)	47.0 dB	46.9 dB	46.9 dB	46.7 dB	46.7 dB	46.5 dB	46.9 dB	47.0 dB	46.7 dB	46.7 dB	46.7 dB	46.5 dB
ENOB (SINAD)	7.5 LSB	7.5 LSB	7.5 LSB	7.5 LSB	7.5 LSB	7.4 LSB	7.5 LSB	7.5 LSB	7.5 LSB	7.5 LSB	7.5 LSB	7.4 LSB
ENOB (SNR)	7.5 LSB	7.5 LSB	7.5 LSB	7.5 LSB	7.5 LSB	7.5 LSB	7.5 LSB	7.5 LSB	7.5 LSB	7.5 LSB	7.5 LSB	7.5 LSB

Dynamic parameters are measured at ±1 V input range (if no other range is stated) and 50Ω termination with the samplerate specified in the table. Measured parameters are averaged 20 times to get typical values. Test signal is a pure sine wave generated by a signal generator and a matching bandpass filter. Amplitude is >99% of FSR. SNR and RMS noise parameters may differ depending on the quality of the used PC. SNR = Signal to Noise Ratio, THD = Total Harmonic Distortion, SFDR = Spurious Free Dynamic Range, SINAD = Signal Noise and Distortion, ENOB = Effective Number of Bits.

## **RMS Noise Level (Zero Noise)**

### **Standard Mode (12 Bit Resolution)**

<b>M5i.3360-x16 and M5i.3367-x16 - 12 Bit 10 GS/s (Channel 0)</b>				
Input Range	$\pm 200$ mV	$\pm 500$ mV	$\pm 1$	$\pm 2.5$ V
Voltage resolution (1 LSB)	97 $\mu$ V	244 $\mu$ V	488 $\mu$ V	1.22 mV
DC, fixed 50 $\Omega$ , typical	3.9 LSB 381 $\mu$ V	3.8 LSB 928 $\mu$ V	4.3 LSB 2.1 mV	4.3 LSB 5.3 mV

<b>M5i.3360-x16 and M5i.3367-x16 - 12 Bit 5 GS/s</b>				
Input Range	$\pm 200$ mV	$\pm 500$ mV	$\pm 1$	$\pm 2.5$ V
Voltage resolution (1 LSB)	97 $\mu$ V	244 $\mu$ V	488 $\mu$ V	1.22 mV
DC, fixed 50 $\Omega$ , typical	4.1 LSB 398 $\mu$ V	3.4 LSB 830 $\mu$ V	3.6 LSB 1.8 mV	3.4 LSB 4.1 mV

<b>M5i.3350-x16 and M5i.3357-x16 - 12 Bit 10 GS/s (Channel 0)</b>				
Input Range	$\pm 200$ mV	$\pm 500$ mV	$\pm 1$	$\pm 2.5$ V
Voltage resolution (1 LSB)	97 $\mu$ V	244 $\mu$ V	488 $\mu$ V	1.22 mV
DC, fixed 50 $\Omega$ , typical	3.9 LSB 381 $\mu$ V	3.8 LSB 928 $\mu$ V	4.3 LSB 2.1 mV	4.3 LSB 5.3 mV

<b>M5i.3350-x16 and M5i.3357-x16 - 12 Bit 5 GS/s</b>				
Input Range	$\pm 200$ mV	$\pm 500$ mV	$\pm 1$	$\pm 2.5$ V
Voltage resolution (1 LSB)	97 $\mu$ V	244 $\mu$ V	488 $\mu$ V	1.22 mV
DC, fixed 50 $\Omega$ , typical	4.0 LSB 391 $\mu$ V	3.3 LSB 806 $\mu$ V	3.6 LSB 1.8 mV	2.9 LSB 3.5 mV

<b>M5i.3330-x16 and M5i.3337-x16 - 12 Bit 6.4 GS/s (Channel 0)</b>				
Input Range	$\pm 200$ mV	$\pm 500$ mV	$\pm 1$	$\pm 2.5$ V
Voltage resolution (1 LSB)	97 $\mu$ V	244 $\mu$ V	488 $\mu$ V	1.22 mV
DC, fixed 50 $\Omega$ , typical	3.7 LSB 361 $\mu$ V	3.0 LSB 732 $\mu$ V	3.8 LSB 1.9 mV	3.5 LSB 4.3 mV

<b>M5i.3330-x16 and M5i.3337-x16 - 12 Bit 3.2 GS/s</b>				
Input Range	$\pm 200$ mV	$\pm 500$ mV	$\pm 1$	$\pm 2.5$ V
Voltage resolution (1 LSB)	97 $\mu$ V	244 $\mu$ V	488 $\mu$ V	1.22 mV
DC, fixed 50 $\Omega$ , typical	3.0 LSB 293 $\mu$ V	2.8 LSB 684 $\mu$ V	3.0 LSB 1.5 mV	2.7 LSB 3.3 mV

<b>M5i.3321-x16 - 12 Bit 3.2 GS/s</b>				
Input Range	$\pm 200$ mV	$\pm 500$ mV	$\pm 1$	$\pm 2.5$ V
Voltage resolution (1 LSB)	97 $\mu$ V	244 $\mu$ V	488 $\mu$ V	1.22 mV
DC, fixed 50 $\Omega$ , typical	2.8 LSB 273 $\mu$ V	2.3 LSB 562 $\mu$ V	2.3 LSB 1.1 mV	2.9 LSB 3.5 mV

### **8-Bit acquisition mode (resolution reduced to 8 bit in hardware)**

<b>M5i.3360-x16 and M5i.3367-x16 - 8 Bit 10 GS/s (Channel 0)</b>				
Input Range	$\pm 200$ mV	$\pm 500$ mV	$\pm 1$	$\pm 2.5$ V
Voltage resolution (1 LSB)	1.56 mV	3.9 mV	7.8 mV	19.5 mV
DC, fixed 50 $\Omega$ , typical	0.5 LSB 780 $\mu$ V	0.5 LSB 1.95 mV	0.5 LSB 3.9 mV	0.5 LSB 9.8 mV

# Hardware block diagram

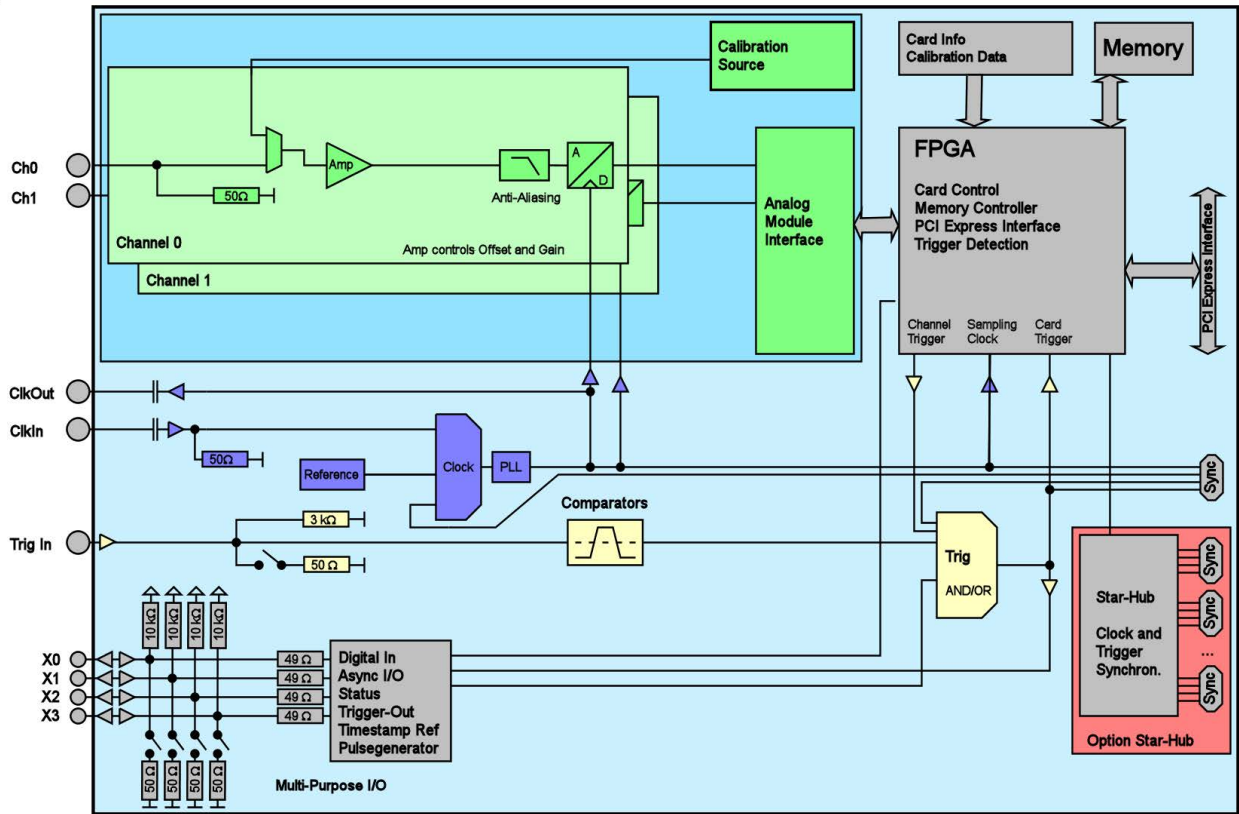

## Order Information

The card is delivered with 2 GSample on-board memory and supports standard acquisition (Scope), FIFO acquisition (streaming), Multiple Recording and Timestamps. Operating system drivers for Windows/Linux 32 bit and 64 bit, examples for C/C++, LabVIEW (Windows), MATLAB (Windows and Linux), IVI, .NET, Delphi, Java, Python, Julia and a Base license of the oscilloscope software SBench 6 are included.

**Adapter cables are not included. Please order separately!**

### PCI Express x16

Order no.	Bandwidth	Standard mem	1 channel	2 channels
M5i.3321-x16	1 GHz	2 GSamples	3.2 GS/s	3.2 GS/s
M5i.3330-x16	2 GHz	2 GSamples	6.4 GS/s	
M5i.3337-x16	2 GHz	2 GSamples	6.4 GS/s	3.2 GS/s
M5i.3350-x16	3 GHz	2 GSamples	10.0 GS/s	
M5i.3357-x16	3 GHz	2 GSamples	10.0 GS/s	5.0 GS/s
M5i.3360-x16	4.7 GHz	2 GSamples	10.0 GS/s	
M5i.3367-x16	4.7 GHz	2 GSamples	10.0 GS/s	5.0 GS/s

### Options

Order no.	Option
M5i.xxxx-MEM8GS	Optional memory extension to 8 GSamples (16 GBytes)
M5i.3321-inptd	M5i.3321-x16 input stage optimized for time domain measurements with smooth step response.
M5i.xxxx-SH8-C2	Synchronization star-hub for up to 8 cards in one system, 2 synchronization cables included
M5i.xxxx-SH8-C4	Synchronization star-hub for up to 8 cards in one system, 4 synchronization cables included
M5i.xxxx-SH8-C8	Synchronization star-hub for up to 8 cards in one system, 8 synchronization cables included
Card-Upgrade	Upgrade for M5i.xxxx: Later installation of star-hub or inptd
M5i.xxxx-SyncCable	Additional synchronization cable for connecting star-hub to one card

### Firmware Options

Order no.	Option
M5i.xxxx-spavg	Signal Processing Firmware Option: Block Average with TDA (later firmware-upgrade available)
M5i.xxxx-PulseGen	Firmware Option: adds 4 freely programmable digital pulse generators that use the XIO lines for output (later installation by firmware-upgrade available)

### Services

Order no.	
Recal	Recalibration at Spectrum incl. calibration protocol

### Standard Cables

for Connections	Length	Order no.				
		to BNC male	to BNC female	to SMA male	to SMA female	to SMB female
Analog/Clk/Trig/XIO	80 cm	Cab-3mA-9m-80	Cab-3mA-9f-80	Cab-3mA-3mA-80		Cab-3f-3mA-80
Analog/Clk/Trig/XIO	200 cm	Cab-3mA-9m-200	Cab-3mA-9f-200	Cab-3mA-3mA-200		Cab-3f-3mA-200
Probes (short)	5 cm		Cab-3mA-9f-5			
Information	The standard adapter cables are based on RG174 cables and have a nominal attenuation of 0.3 dB/m at 100 MHz and 0.5 dB/m at 250 MHz. For high speed signals we recommend the low loss cables series CHF					

### Low Loss Cables

Order No.	Option
CHF-3mA-3mA-200	Low loss cables SMA male to SMA male 200 cm
CHF-3mA-9m-200	Low loss cables SMA male to BNC male 200 cm
Information	The low loss adapter cables are based on MF141 cables and have an attenuation of 0.3 dB/m at 500 MHz and 0.5 dB/m at 1.5 GHz. They are recommended for signal frequencies of 200 MHz and above.

### Amplifiers

Order no.	Bandwidth	Connection	Input Impedance	Coupling	Amplification
SPA.1841 <sup>(2)</sup>	2 GHz	SMA	50 Ohm	AC	x100 (40 dB)
SPA.1801 <sup>(2)</sup>	2 GHz	SMA	50 Ohm	AC	x10 (20 dB)
SPA.1601 <sup>(2)</sup>	500 MHz	BNC	50 Ohm	DC	x10 (20 dB)
Information	External Amplifiers with one channel, BNC/SMA female connections on input and output, manually adjustable offset, manually switchable settings. An external power supply for 100 to 240 VAC is included. Please be sure to order an adapter cable matching the amplifier connector type and matching the connector type for your A/D card input.				

### Software SBench6

Order no.	
SBench6	Base version included in delivery. Supports standard mode for one card.
SBench6-Pro	Professional version for one card: FIFO mode, export/import, calculation functions
SBench6-Multi	Option multiple cards: Needs SBench6-Pro. Handles multiple synchronized cards in one system.
Volume Licenses	Please ask Spectrum for details.

### Software Options

Order no.	
SPc-RServer	Remote Server Software Package - LAN remote access for M2i/M3i/M4i/M4x/M2p/M5i cards
SPc-SCAPP	Spectrum's CUDA Access for Parallel Processing - SDK for direct data transfer between Spectrum card and CUDA GPU. Includes RDMA activation and examples.

<sup>(1)</sup> : Just one of the options can be installed on a card at a time.

<sup>(2)</sup> : Third party product with warranty differing from our export conditions. No volume rebate possible.

### Technical changes and printing errors possible

SBench, digitizerNETBOX, generatorNETBOX and hybridNETBOX are registered trademarks of Spectrum Instrumentation GmbH. Microsoft, Visual C++, Windows, Windows 98, Windows NT, Window 2000, Windows XP, Windows Vista, Windows 7, Windows 8, Windows 10 and Windows 11 are trademarks/registered trademarks of Microsoft Corporation. LabVIEW, DASYLab, Diadem and LabWindows/CVI are trademarks/registered trademarks of National Instruments Corporation. MATLAB is a trademark/registered trademark of The Mathworks, Inc. Delphi and C++ Builder are trademarks/registered trademarks of Embarcadero Technologies, Inc. IVI is a registered trademark of the IVI Foundation. Oracle and Java are registered trademarks of Oracle and/or its affiliates. Python is a trademark/registered trademark of Python Software Foundation. Julia is a trademark/registered trademark of Julia Computing, Inc. PCIe, PCI Express and PCI-X and PCI-SIG are trademarks of PCI-SIG. LXI is a registered trademark of the LXI Consortium. PICMG and CompactPCI are trademarks of the PCI Industrial Computer Manufacturers Group. Intel and Intel Core i3, Core i5, Core i7, Core i9 and Xeon are trademarks and/or registered trademarks of Intel Corporation. AMD, Opteron, Sempron, Phenom, FX, Ryzen and EPYC are trademarks and/or registered trademarks of Advanced Micro Devices. Arm is a trademark or registered trademark of Arm Limited (or its subsidiaries). NVIDIA, CUDA, GeForce, Quadro, Tesla and Jetson are trademarks/registered trademarks of NVIDIA Corporation.